

## CGP-60 Patterned Stainless Steel Corner Guard

- Type 304 #4 satin finish patterned stainless steel
- 3 1/2-inch wing size
- 1/8-inch corner radius
- 135-degree angle
- Manufacturer's standard patterns
- Custom lengths, angles, and wing sizes available
- Other stainless steel grades and finishes available

### Standard Lengths

- 48-inch
- 96-inch
- 120-inch

### Mounting Options

- ADH-50 silicone sealant adhesive
- Mechanical fasteners (supplied by others)
- Pre-drilled mounting holes available

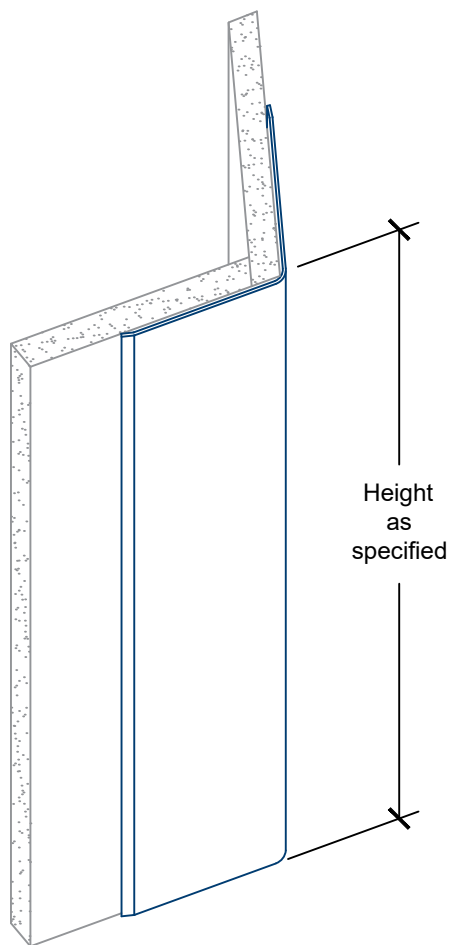
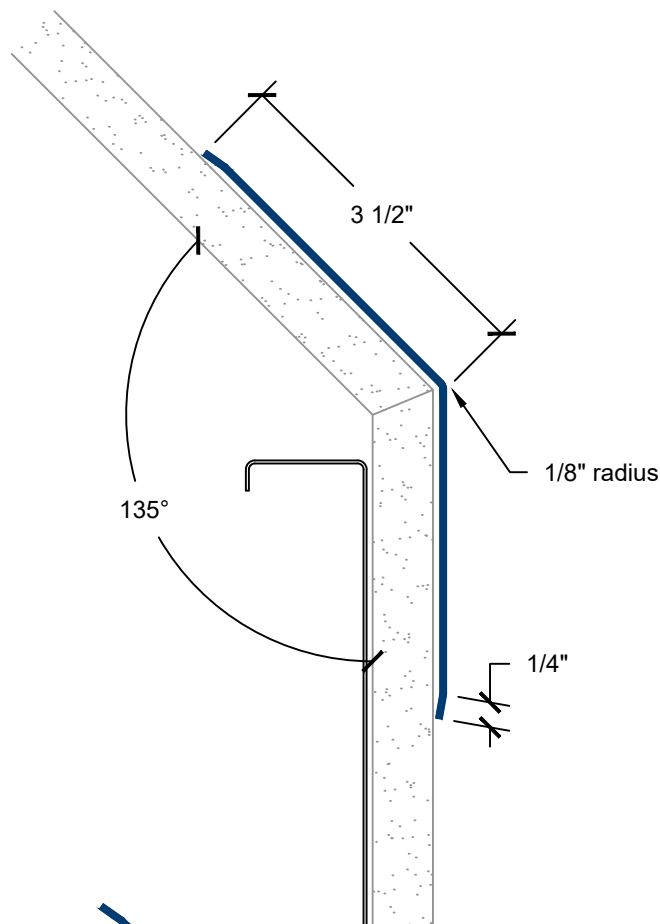

### Spacing for optional drilled holes

- 3-inches from ends
- Spaced equally not to exceed 36-inches
- Specify punched or countersunk holes

